



# ROCK KIDS

PRAYER GUIDE

# TABLE OF CONTENTS

---

03	LIFESTYLE PRAYER
07	THE LORD'S PRAYER
22	TABERNACLE PRAYER
42	PRAYER AND SCRIPTURE FOR EVERY DAY
47	PRAYERS FOR WHEN I NEED HELP
50	PRAYERS FOR MY FAMILY
51	PRAYERS FOR WHEN I FEEL ALONE
52	PRAYERS FOR WHEN I FEEL AFRAID
54	PRAYERS FOR PROTECTION
56	THE PRAYER OF JABEZ
65	PRAYERS FOR OTHERS
66	PRAYERS FOR ME
70	AWCIPA PRAYER MODEL

# DEAR FRIEND,

We are so proud of you as you begin, or continue, this powerful journey of discovering your own personal prayer life. Learning what prayer is, how to pray, and how important prayer is to your everyday life is one of the most important things you can do as a believer in Jesus. From day one, our church has always set out to be a people of prayer. We want to pray first in every situation, good or bad, because Prayer is our Priority. Jesus is always the answer, He is our best friend, and He is always ready to talk with us.

Praying with Jesus is not only something that we need in our lives but it should be something that we *want* to do. The more we learn about prayer, the easier it becomes. The easier it becomes, the more fun it is! Praying and talking with Jesus should be the best part of our day! We hope you will use this prayer journal to make your prayer life more personal. When you find out how to have real conversations with Jesus every day, then you will experience the presence of God, and that will change your life in the best way possible.

Once you learn how to pray, you can make it a part of your everyday life. You can pray:

- Before the day begins
- Before you go to school
- Before you hang out with your friends
- Before practice
- Before you play a big game
- Before you go to bed
- When something bad happens
- When something good happens
- In every situation – PRAY FIRST!

Always remember, Prayer is our Priority.

The Rock Kids Team

# LIFESTYLE PRAYER

*Very early in the morning, while it was still dark, Jesus got up, left the house and went off to a solitary place, where He prayed.  
(Mark 1:35)*

---

## Here's what we see:

He prayed every day.  
He prayed in a certain place.  
He prayed with a plan.

## 1. TIME

We see that Jesus had a certain time that He prayed every day. The Bible says that Jesus got up very early in the morning to spend time with His Heavenly Father and pray. He had a specific time that He always knew was His prayer time. We should do the same.

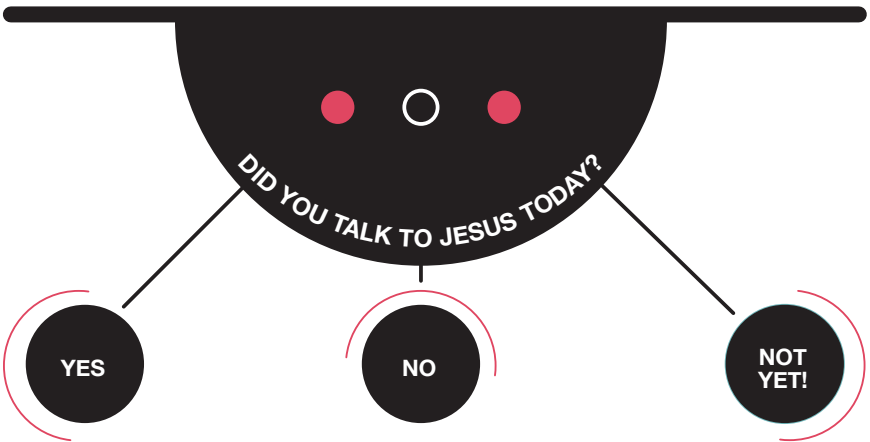

When will your prayer time be? Use a pencil to circle your answer or answers!

WHEN I WAKE UP

IN THE AFTERNOON

BEFORE I GO TO SLEEP

**USE A PENCIL AND FILL IN  
THE TIME THAT YOU PRAYED  
TODAY!**

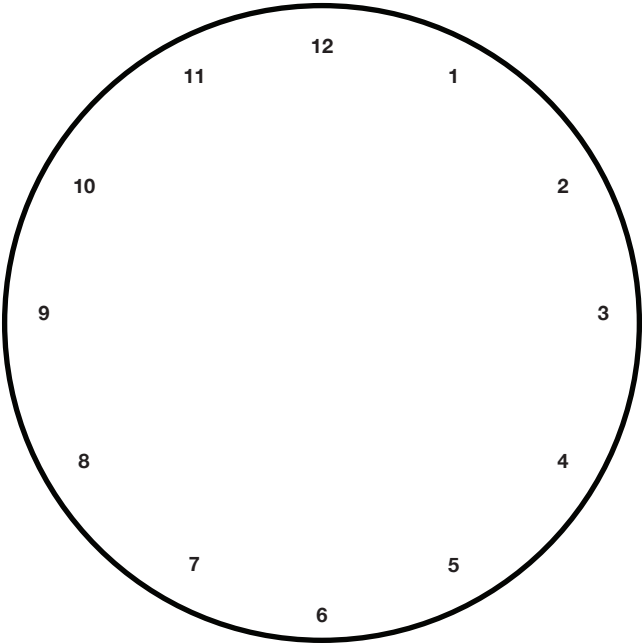

## 2. PLACE

We see that Jesus had a certain place that He would go to pray. We need to have a place that doesn't have any distractions, noises, or things that would keep us from focusing on Jesus.

My favorite place to pray is: \_\_\_\_\_

---

**COLOR IN THE PLACE  
BELOW WHERE YOU LIKE  
TO PRAY TO JESUS.**

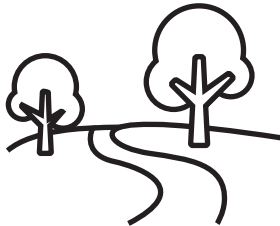

### 3. PLAN

We also see in the Bible that whenever Jesus prayed, He always had a plan. He had things on His heart that He wanted to pray for, and knew how He wanted to pray for them.

---

**WRITE DOWN OR DRAW A  
PICTURE BELOW OF THE  
PEOPLE AND THINGS YOU  
CAN PRAY FOR TODAY!**

---

---

---

# THE LORD'S PRAYER

*One day Jesus was praying in a certain place. When He finished, one of His disciples said to Him, "Lord, teach us to pray..."*  
(Luke 11:1)

---

"Our Father in heaven, hallowed be Your name. Your kingdom come. Your will be done on earth as it is in heaven. Give us this day our daily bread. And forgive us our debts, as we forgive our debtors. And do not lead us into temptation, but deliver us from the evil one. For Yours is the kingdom and the power and the glory forever. Amen."

(Matthew 6:9-13 NKJV)



**“OUR FATHER IN  
HEAVEN...”**

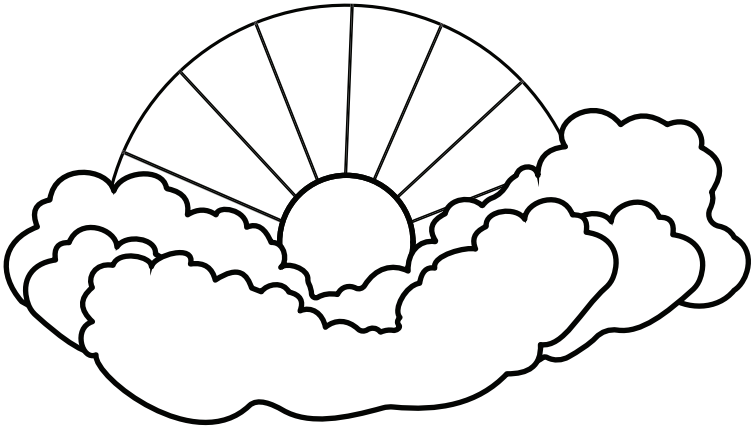

**Connect with God. He is your loving Father.**



“...HALLOWED BE  
YOUR NAME...”

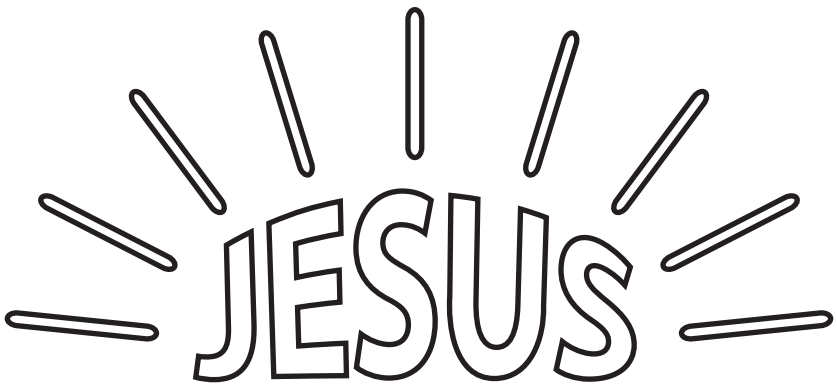

**Worship His name.**

*God's name is a place of protection—good people can run there  
and be safe. (Proverbs 18:10 MSG)*

# MATCH WHO HE IS WITH WHAT HE CAN DO!

**Healer** God is on my side and will fight for me.

**Friend** God is in charge and wants the best for me.

**Peace** I will choose joy because God is my joy.

**Forgiveness** He is my hope for every situation.

**Love** He forgives me for anything I have done and will do.

**Hope** Jesus loves me the most.

**Joy** He brings me peace no matter what I go through.

**King** He is always with me.

**Protector** God heals all our diseases.



“...YOUR KINGDOM COME.  
YOUR WILL BE DONE  
ON EARTH AS IT IS IN  
HEAVEN...”



**Pray for what He wants (Pray His agenda first).**

*He will always give you all you need from day to day if you will make the Kingdom of God your primary concern.  
(Luke 12:31 TLB)*

# THE BEST THING WE COULD EVER WANT IS WHAT GOD WANTS.

He will take care of everything else we need!

List below and pray through the things God wants for  
the world and for you.

---

---

---

---

---

---

---

---

---

---

---

---

---

---

---

“...GIVE US THIS DAY OUR  
DAILY BREAD...”

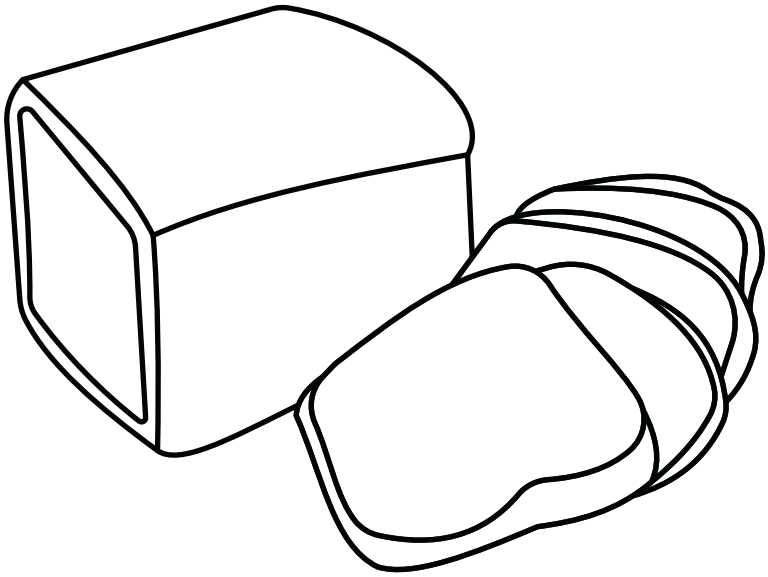

**Ask God for what you want and need, and then trust Him to provide for you.**

*I look up to the mountains—does my help come from there?  
My help comes from the LORD, who made heaven and earth!  
(Psalm 121:1-2 NLT)*

# WHAT ARE YOU TRUSTING GOD FOR?

Write some of your answers below.

---

---

---

---

---

---

---

---

---

---

---

---

---

---

---

---

---

---

---

---

---



**“...AND FORGIVE US OUR  
DEBTS, AS WE FORGIVE  
OUR DEBTORS...”**

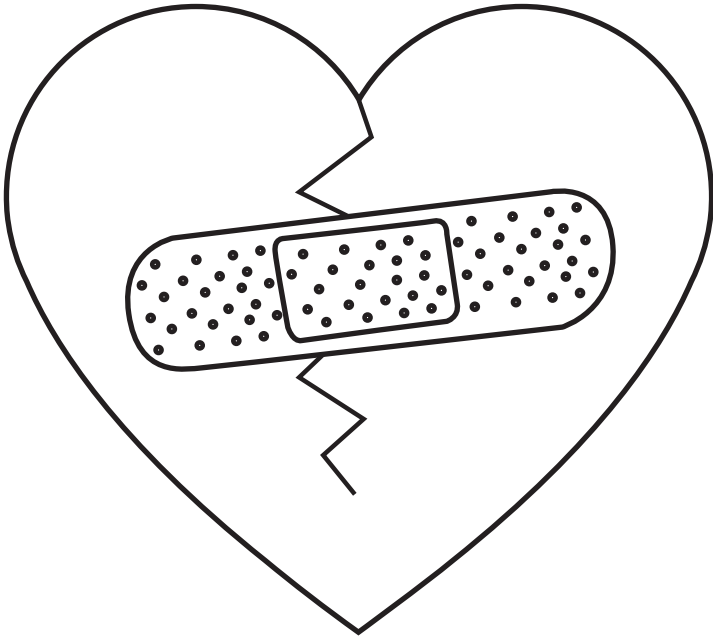

**Make sure your heart is right with God and with people.**

*If we confess our sins, He is faithful and just and will forgive us  
our sins and purify us from all unrighteousness.*

*(1 John 1:9)*

# ASK JESUS TO LOOK INSIDE YOUR HEART:

**1. What do you need to ask for forgiveness for?**

**2. What do you need to forgive someone for?**

Once you have prayed, color in the sentences below.

I AM FORGIVEN.

I CAN FORGIVE.

**“ ...AND DO NOT LEAD US  
INTO TEMPTATION, BUT  
DELIVER US FROM  
THE EVIL ONE...”**

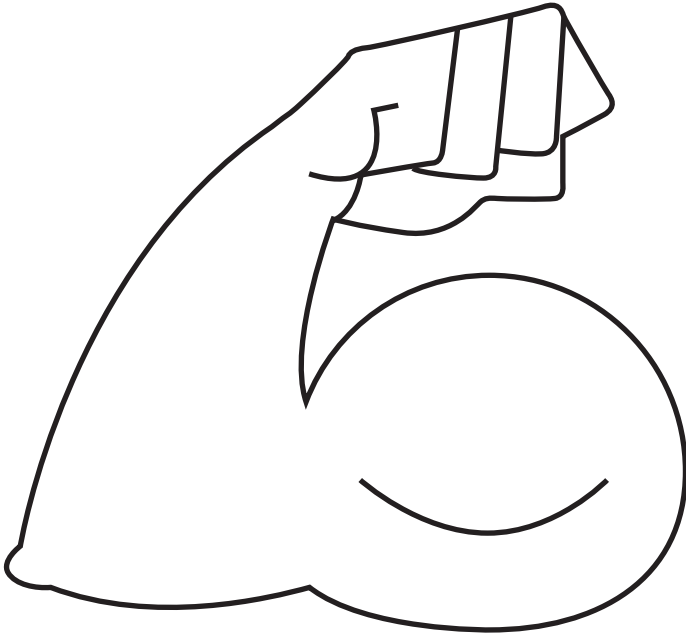

**Replace any lie the enemy has told you with the truth of God's Word.**

*For our struggle is not against flesh and blood, but against the rulers, against the authorities, against the powers of this dark world and against the spiritual forces of evil in the heavenly realms. (Ephesians 6:12)*

# GOD'S WORD IS TRUTH.

Replace the lies you may have heard with what God says is true.

## LIE I HAVE HEARD

## WHAT GOD SAYS IS TRUE

"I am mean." \_\_\_\_\_ I can be a friend like Jesus.

"I am ugly." \_\_\_\_\_ I am fearfully and wonderfully made.

"I don't have friends." \_\_\_\_\_ Jesus loves me and I am never alone.

"If I lie, I won't get in trouble." \_\_\_\_\_ I can tell the truth and not be afraid.

"If I do what's wrong, I'll finally fit in." \_\_\_\_\_ My identity comes from Jesus.



**“ ...FOR YOURS IS THE  
KINGDOM AND THE POWER  
AND THE GLORY FOREVER.  
AMEN.”**

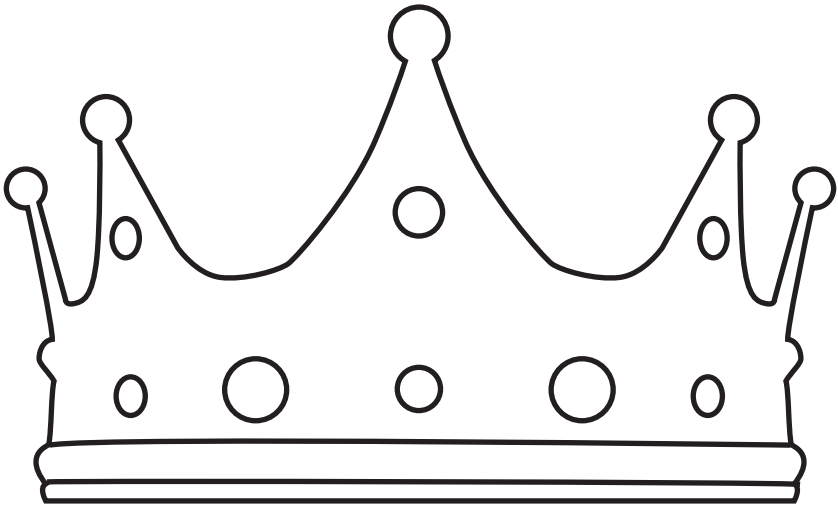

**God can do anything (believe it)!**

*Ah, Sovereign LORD, You have made the heavens and the earth by Your great power and outstretched arm. Nothing is too hard for You. (Jeremiah 32:17)*

“FOR YOURS IS  
THE KINGDOM AND  
THE POWER AND THE  
GLORY FOREVER. AMEN.”

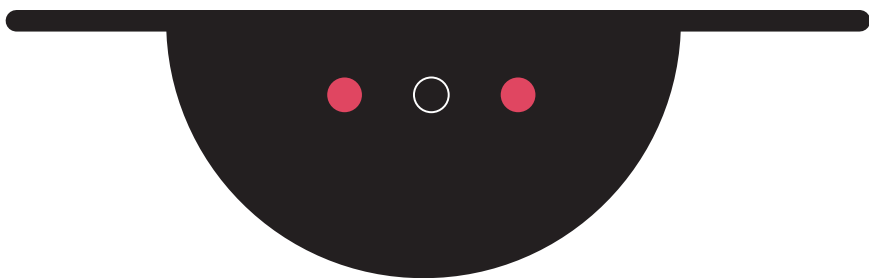

# TABERNACLE PRAYER

---

Since the beginning, God always wanted to be with us. In the Old Testament, God told Moses to build a place called the Tabernacle. The Tabernacle is where God lived here on earth, where He would meet His people, and where they could worship Him. As the people entered the Tabernacle, they followed God's instructions by passing through seven stations to experience His presence. Today, even though we no longer need the physical Tabernacle to meet with God, these same steps can help us connect with Him. Each station of the Tabernacle can be used to guide our prayers.

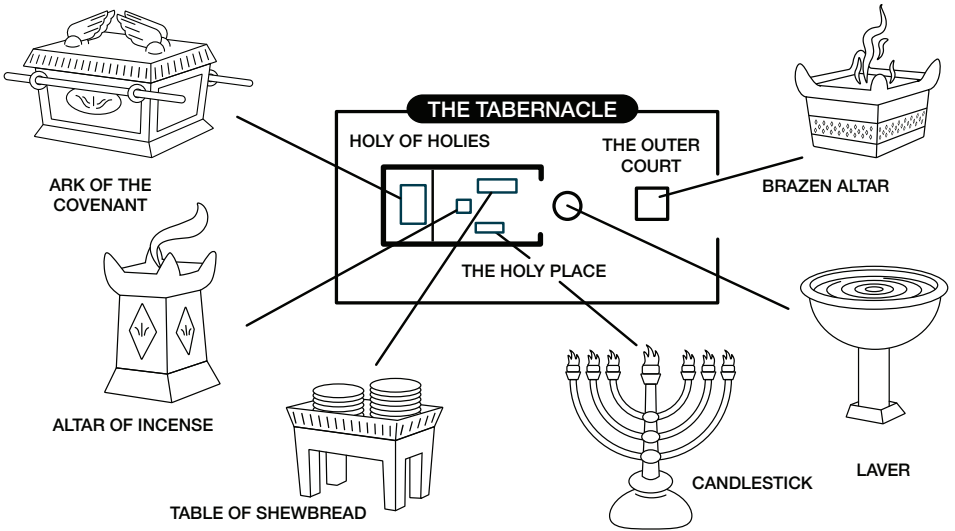

# 1 THE OUTER COURT

## Thanksgiving and Praise

---

The Israelites walked into the Tabernacle with thanksgiving and praise. We can start our prayers the same way.

*Enter His gates with thanksgiving and His courts with praise; give thanks to Him and praise His name.  
(Psalm 100:4)*

### **Prayer:**

“Father God, You are good, and You deserve all my praise. Thank You for the many ways You have blessed me and for watching over me (tell Him specific things in your life that you’re grateful for. Thank Him for something that you’ve never thanked Him for). Lord be with me. I want to experience Your presence and Your love in a new way today, Jesus. Thank You that no matter what happens, You always love me. I find hope in Your never-ending forgiveness and care. Thank You for who You are and all You have done for me.”





## 2 THE BRAZEN ALTAR

The Cross of Jesus

---

In the Old Testament, everyone had to bring animals to sacrifice as payment for their sins. Today, we don't have to do that because Jesus paid for our sins by dying on the cross.

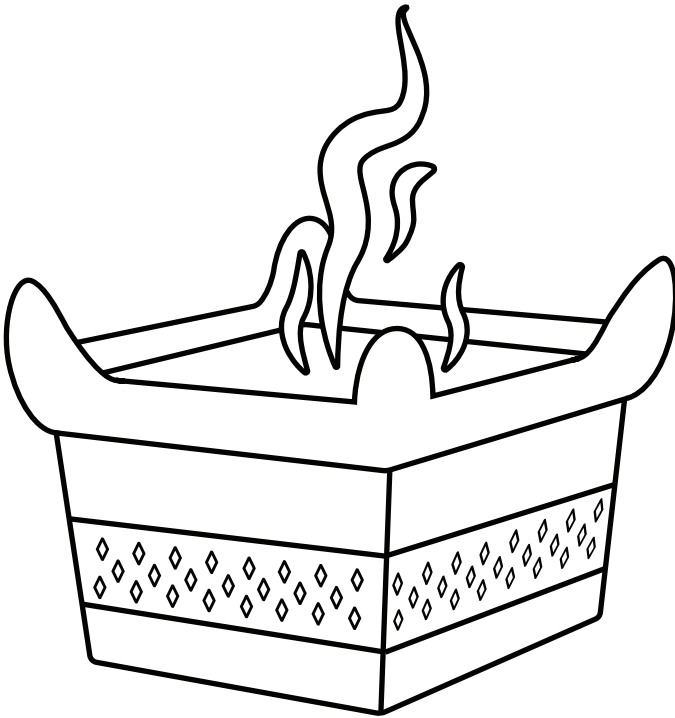

# THE CROSS OF JESUS

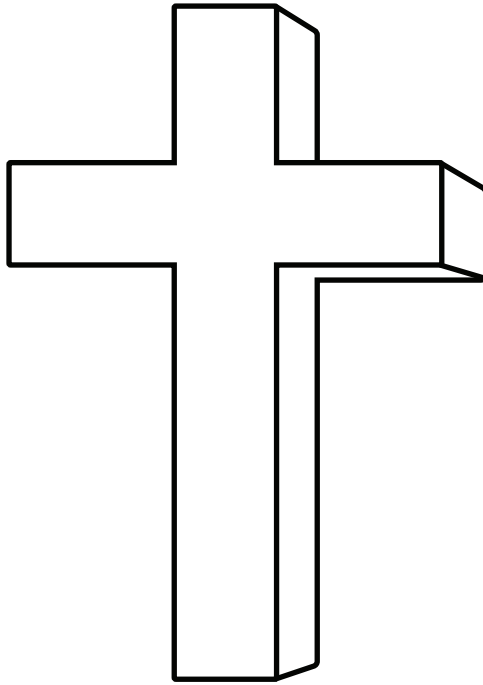

Thank God for sending Jesus to die for our sins so that we don't have to! Thank Jesus for His sacrifice and His love. Really think about the sacrifice Jesus made. He loves you so much that He paid for the consequences of our sin. He didn't have to, but He wanted to make a way for us to live with Him one day. Jesus can change our hearts and make us better because of what He did on the cross.

The cross gives us five incredible benefits:

- Salvation – God forgives all my sins
- Healing – God heals all my diseases
- Redemption – God rescues me and restores me
- Transformation – God changes my heart to be more like His
- Blessing – God gives me everything I need

*Let all that I am praise the LORD; may I never forget the good things He does for me. He forgives all my sins and heals all my diseases. He redeems me from death and crowns me with love and tender mercies. He fills my life with good things. My youth is renewed like the eagle's!  
(Psalm 103:2-5 NLT)*

**Prayer:**

“Thank You, God, for making a way for me to be with You through Your Son, Jesus, thank You for the sacrifice You made for me on the cross. You saved me and You set me free by paying for my sins. I praise You for being my Healer. You have power over all disease and harm in my life (list areas where you need God to heal you). Thank You for being my Redeemer. You rescue me from sin and give my life purpose. Thank You for changing my life with Your love and for making me new. I want to grow to be more like You (give God control of every area in your life). Thank You for blessing me and for giving me the things I need. I know You have good plans for me, and all that I have comes from You (thank Him for blessings in your life).”

### 3 THE LAVER

#### Cleansing and Preparing

---

The next step in the Tabernacle was a bowl of water where people were reminded of their need to be washed clean of their sins and forgiven by God. Unfortunately, all of us sin. But it's an important part of our daily prayer to surrender our lives to God by giving Him control over all areas in our life. With His help, we can make the right decisions and follow God's plan for our lives.

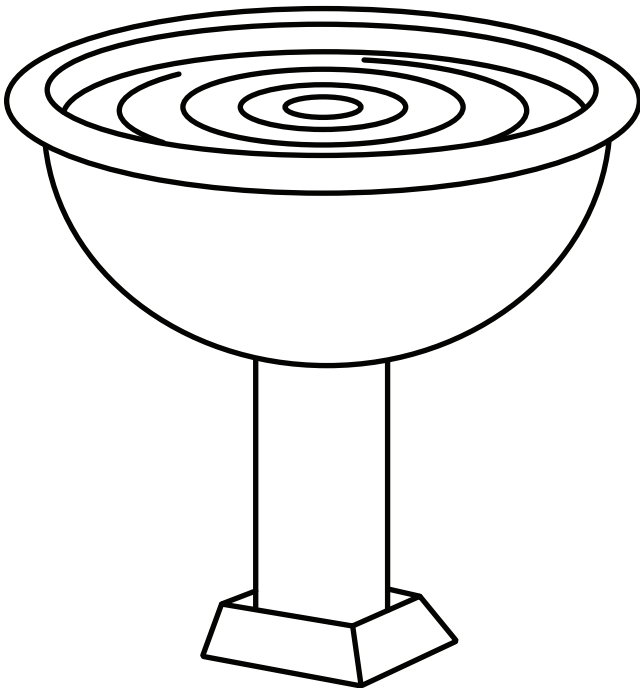

*So then, my friends, because of God's great mercy to us I appeal to you: Offer yourselves as a living sacrifice to God, dedicated to His service and pleasing to Him. This is the true worship that you should offer.  
(Romans 12:1 GNT)*

Unfortunately, sometimes we do what we want instead of what God wants. We all fall short of God's standard, and we all struggle with sin. Because of what Jesus did on the cross, we can confess and tell Him our sins, receiving complete forgiveness and a fresh start. While you pray, be humble and turn away from your sins and allow God to wash you clean and renew you. Then, surrender your life to Him. Give your will and thoughts to God and allow Him to help you make the right decisions.

**Prayer:**

“God, I confess my sins to You and turn away from them (tell God any sin you know is in your life. Ask Him to show you any other areas that need to change). Thank You, God, for freely forgiving me. As I turn away from my sin, I turn toward You, and I give myself to You:

- I give You my tongue, to speak good and not evil
- I give You my eyes, to focus on You and the needs of others
- I give You my ears, to listen to Your voice
- I give You my hands, to do good for others
- I give You my feet, to walk where You lead me
- I give You my mind, to think positive things and to be transformed and used by You

I ask You, Lord, for the amazing gifts of Your Holy Spirit, so that I can grow closer to You and make a difference in the lives of others. I ask for love, joy, peace, patience, kindness, goodness, faithfulness, gentleness, and self-control. God, help me do what is right.”

# FRUIT OF THE SPIRIT

When we follow Jesus and let the Holy Spirit lead us, we become more like Him.



## 4 THE CANDLESTICK

### The Holy Spirit

---

The next piece of the Tabernacle was a seven-branched golden candlestick. The fire represents the Holy Spirit and how we are called to be a light in the world's darkness by helping others experience the love of God.

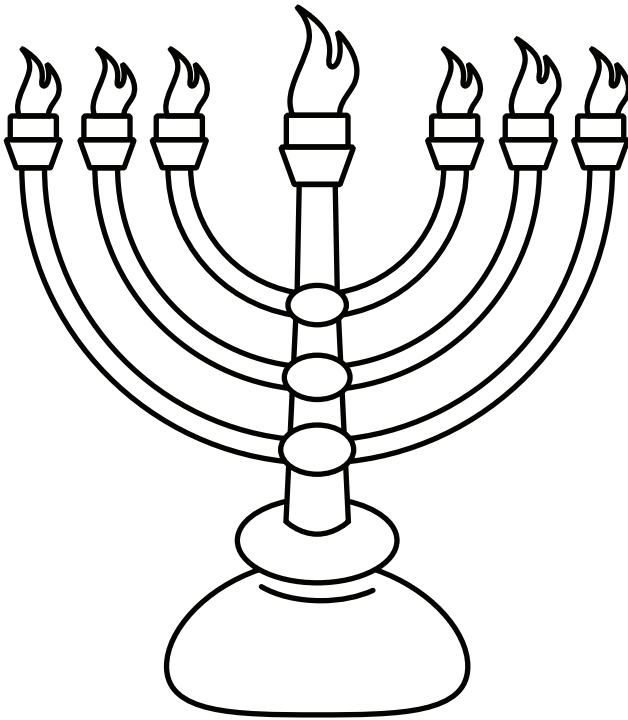



*The Spirit of the LORD will rest on him—the Spirit of wisdom and of understanding, the Spirit of counsel and of might, the Spirit of the knowledge and fear of the LORD.  
(Isaiah 11:2)*

When Jesus left the earth, Christians were given the gift of the Holy Spirit. He calls the Holy Spirit our “advocate,” our supporter. The Holy Spirit helps us with everything we need. We can’t do what God has called us to do without His supernatural power. It is through the Holy Spirit that God comforts us, guides us, and helps us.

**Prayer:**

“Holy Spirit, I ask You to fill me up. I need Your presence in my life – guiding, directing, comforting, and helping me. I know that You, Holy Spirit, are God. Help me to see how great You are. Help me to be amazed and in awe of who God is and what He does. Work in me, Holy Spirit. Teach and transform me (pray for any areas where you feel the need for change today). I honor You and ask You to help me love others the way You love them.”

## 5 THE TABLE OF SHEWBREAD

The Word of God

---

In the Tabernacle, a table with twelve loaves of bread was set up to show the importance of reading God's Word. Eating bread nourishes and strengthens us. Without eating, we can't live. The same goes for when we read the Bible—it satisfies and strengthens our spirit. Reading God's Word regularly keeps us healthy and helps us become more like Jesus.

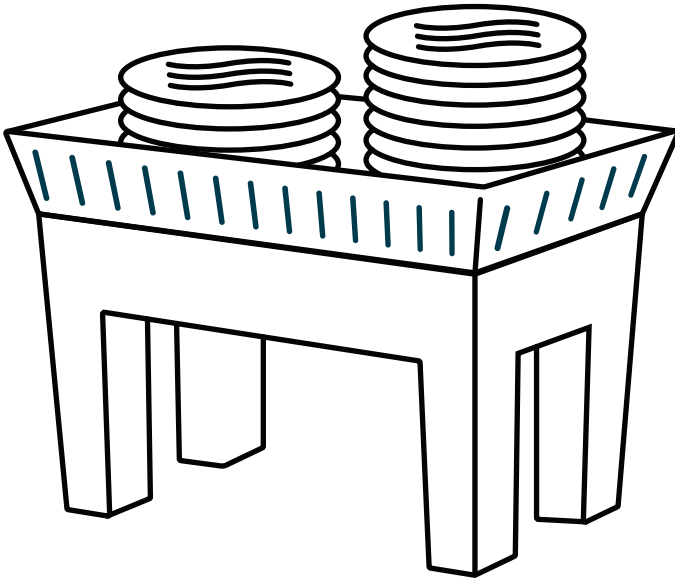

# THE WORD OF GOD

God's Word, the Bible, is an incredible gift and a powerful tool to use in our daily lives. Here is how you can use God's Word in your prayers:

- Take time to read the Bible and think about what you read
- Find hope in the many promises God has for your life
- Ask Him to show and teach you things you didn't know before
- Ask Him for a Word to help you as you start your day

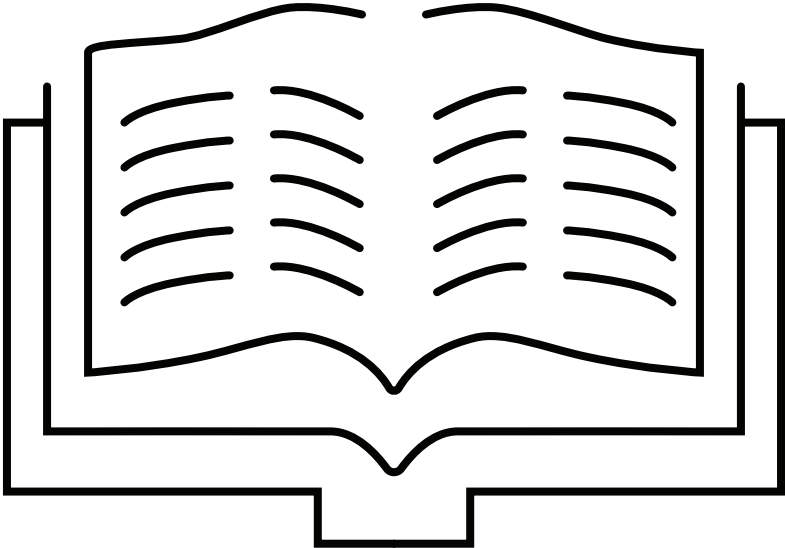

*Keep this Book of the Law always on your lips; meditate on it day and night, so that you may be careful to do everything written in it. Then you will be prosperous and successful. (Joshua 1:8)*

**Prayer:**

“Thank You, God, for giving me Your Word, the Bible. I commit to reading it, and I ask You to speak to me through it and show me who You are. Help me to grow more in love with You and Your Word, and help me use it more. I find hope in the promises You have for me, and I know what You say is true (pray any Scriptures that are on your mind or read them out loud). Teach me more about You today and every day! I want to know You more, and I want to see You more clearly through Your Word.”

## 6 THE ALTAR OF INCENSE

Worship

---

A small altar of burning incense stood at the entrance to the Holy of Holies, where God's presence lived. The people of God worshipped His Names as they entered into His presence. (In the Bible there are many names that show us what God has done for us.) This altar represents worship and how much God loves it when we worship Him.

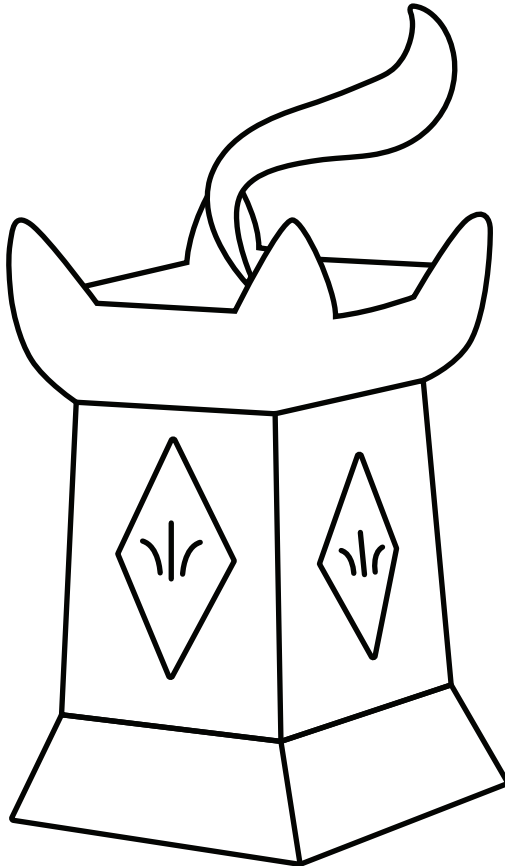

*The name of the LORD is a strong tower; the righteous run to it and are safe. (Proverbs 18:10 NKJV)*

Thank God for wanting to be with you. When you pray, consider these names that the Bible gives us to describe who God is.

**My Righteousness** – Jeremiah 23:6 – God is righteous, and when you accept Jesus into your heart you will become righteous. It means that He paid the price for your sin so that you have right standing with God.

**My Sanctifier** – Leviticus 20:7-8 – God continually works in you to change you so you can become more like Jesus. God sets you apart and makes you holy.

**My Healer** – Exodus 15:26 – Jesus can comfort and heal you when you are not feeling well. God can heal your mind, your body, and your spirit.

**My Provider** – Genesis 22:14 – God will provide for you. Be hopeful and confident that God will do great things for you. This does not mean He gives you what you want, but what you need.

**My Banner of Victory** – Exodus 17:15 - A banner, like a flag, is lifted high to celebrate, and we find victory in what Jesus has done for us on the cross. He is always faithful. **My Peace** – Judges 6:24 – Trust God; He will give you peace in every situation.

**My Shepherd** – Psalm 23:1 – Just like a shepherd caring for his sheep, God will lead you, provide for you, and care for your needs. He is always there for you and will never leave you.

### **Prayer:**

“Thank You, God, for wanting to be with me. Thank You for Your presence. I know that You are here with me. I worship You and You alone. I know, God, that You are: my Righteousness, my Sanctifier, my Healer, my Provider, my Banner of Victory, my Peace, and my Shepherd. (As you pray, praise His Names and worship Him personally and specifically for who He is and what He has done in your life.) I know that You are always with me, God, and Your presence means everything. You give me life, joy, and purpose. I love you, God.”



## 7 THE ARK OF THE COVENANT

### Intercession

---

The final place in the Tabernacle was the Holy of Holies, the most holy place where God lived. Only the Priests could go in there. Once inside, they would pray for other people. Today, since we all have access to the presence of God through Jesus, we can do the same thing by praying for those around us. When we pray for others it is called “intercession.”

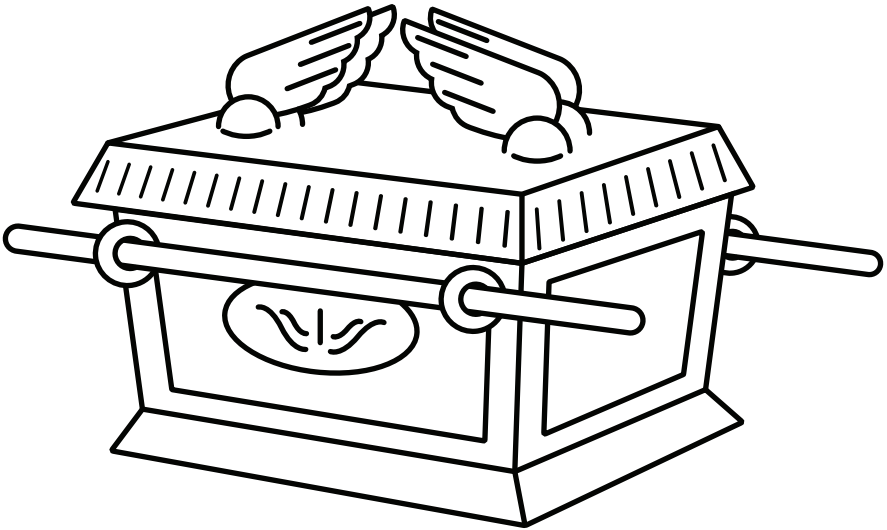



*I urge you, first of all, to pray for all people. Ask God to help them; intercede on their behalf, and give thanks for them. Pray this way for kings and all who are in authority so that we can live peaceful and quiet lives marked by godliness and dignity. This is good and pleases God our Savior, who wants everyone to be saved and to understand the truth. (1 Timothy 2:1-4)*

We can make a difference when we spend time praying for others. Pray for the people around you, including:

- Those in authority – People who guide you and help you make good decisions such as your leaders in church, your parents, your family, and your teachers
- Your family – Your parents, grandparents, siblings, aunts, uncles, and cousins
- Your church – Pastors, Small Group leaders, HK leaders, and friends from church
- Your community – People in your neighborhood, in your city, nation, and world
- Your relationships – Friends, people from your school or sports

**Prayer:**

“Thank You, God, for creating a way through Jesus for me to have Your presence wherever I go. I want to specifically ask You to watch over those in authority over me – my parents, the leaders at my church, and my teachers (use their name when you pray for them). I ask that You give them wisdom and grace, watch over and protect them, and help them to know and love You more.

I ask You, God, to be with my family. Bless them and keep them from harm (pray for anything that your family needs). For those in my family who don't know You, come to them and meet them where they are, and guide their hearts to You.

God, I ask You to watch over my church. Protect my pastor, be with my leaders, and I pray for everyone that comes to church. I pray that You will bring new people to church who don't know You yet, and that they will have a great time and come to know You.

I ask You to watch over my neighborhood and my city, my nation, and the world. Bring peace and help us get to know You better. I pray for Your help to show the love of Jesus to everyone who I get to meet. I pray that they will see Your light in me.

I pray for my friends, my neighbors, and my classmates. Thank You for them and please bless them (pray for any specific needs of others).

Lastly, God, I give You the things I care about. I know that You help me, that You give me what I need, and that You care for me. I give You all of my needs (share the needs on your mind). Thank You for loving me, choosing me, and calling me Yours. In Jesus' name, amen.”

# PRAYER AND SCRIPTURE FOR EVERY DAY

---

## MY PRAYER LIST

Make a list of things you want to pray for every day.

---

---

---

---

---

---

---

---

---

---

---

---

# TELL JESUS HOW GREAT HE IS.

A jump start to praying this way is below. Fill in the blanks and add your own praise and worship as you talk to Jesus about how great He is!

Look up Scripture as you walk through the outline.

## Hi Jesus!

I love You so much!

Thank You \_\_\_\_\_ . (*Psalm 100:4; 118:24*)

I love that You created \_\_\_\_\_ .

When I'm outside, I notice \_\_\_\_\_ in Your beautiful creation!

God, You made me. Thank You for my ability to \_\_\_\_\_ . (*Mark 12:30*)

You love me for who I am, no matter what.

Thank You for being my God and my Friend. I love You!

In Jesus' name, amen.

# GIVE THANKS EVERY DAY.

Having a thankful heart is something that Jesus loves. Giving thanks to God makes even bad days good. A jump start to praying this way is below. Fill in the blanks and add your own words of thankfulness!

## Hi Dad!

I am so thankful for You and all that You have given me.

Today, I thank You for my family!

I pray that for my family You would \_\_\_\_\_ .

I thank You that I get to wake up and have a new day!

I pray today for \_\_\_\_\_ .

Thank You for the food I get to eat, the clothes I get to wear, and the house I get to live in.

Thank You for \_\_\_\_\_ .

Thank You for dying for me and saving me.

Help me be more like You, Jesus.

I am so thankful for You! I love You! (*Psalm 96:1-2*)

In Jesus' name, amen.

# ASK GOD TO LEAD YOU EVERY DAY.

Have you ever been lost and not know where you were going? It's not a fun feeling. The easiest way to avoid this is to ask for directions from someone with a map. Jesus has the map to life and has the best plan for your life.

**Follow the numbers 1-5 and color in the road map on the next page as you ask Jesus to lead you today!**

1. Thank You, Jesus, for the plan You have for me!
2. Today I choose Your plan for my life, because I know it's the best plan there is!
3. Lead me. Give me words to say. Help me think good thoughts.
4. Help me to be kind to people, be wise, and make good choices.
5. Jesus, please make me more like You every day. In Jesus' name, amen.

*(Proverbs 3:5-7; Psalm 131:1-3; Isaiah 30:21)*

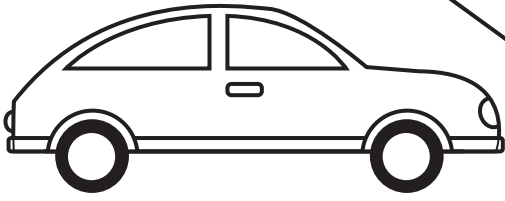

1

2

3

5

4

# PRAYERS FOR WHEN I NEED HELP

---

## Pray through the Armor of God.

Read Ephesians 6:11-18 and then say a prayer to God like the one on the next page to put on your armor!

“Put on the full armor of God, so that you can take your stand against the devil’s schemes. For our struggle is not against flesh and blood, but against the rulers, against the authorities, against the powers of this dark world and against the spiritual forces of evil in the heavenly realms. Therefore, put on the full armor of God, so that when the day of evil comes, you may be able to stand your ground, and after you have done everything, to stand. Stand firm then, with the **belt of truth** buckled around your waist, with the **breastplate of righteousness** in place, and with your feet fitted with the readiness that comes from the **gospel of peace**. In addition to all this, take up the **shield of faith**, with which you can extinguish all the flaming arrows of the evil one. Take the **helmet of salvation** and the **sword of the Spirit**, which is the Word of God. And pray in the Spirit on all occasions with all kinds of prayers and requests. With this in mind, be alert and always keep on praying for all the Lord’s people.”

*(Ephesians 6:11-18)*



# PRAYING THROUGH THE ARMOR OF GOD...

**Lord,**

Today, I put on the full armor of God. I am protected.

I put on the **belt of truth** to speak and walk honestly.

I will put into place the **breastplate** to do what is morally right.

I will strap onto my feet and be ready with the **gospel of peace**.

On my arm, I will carry the **shield of faith** and block the attacks from the evil one. I know God is with me.

On my head, I will wear the **helmet of salvation**. Jesus loves me and I belong to Him!

With my shield in one hand, I will carry the **sword of the Spirit** with me in the other. It is the Word of God.

I will pray on all occasions, everywhere, for anything. I will be alert and never stop praying daily for those around me.

In Jesus' name, amen.

# THE ARMOR OF GOD

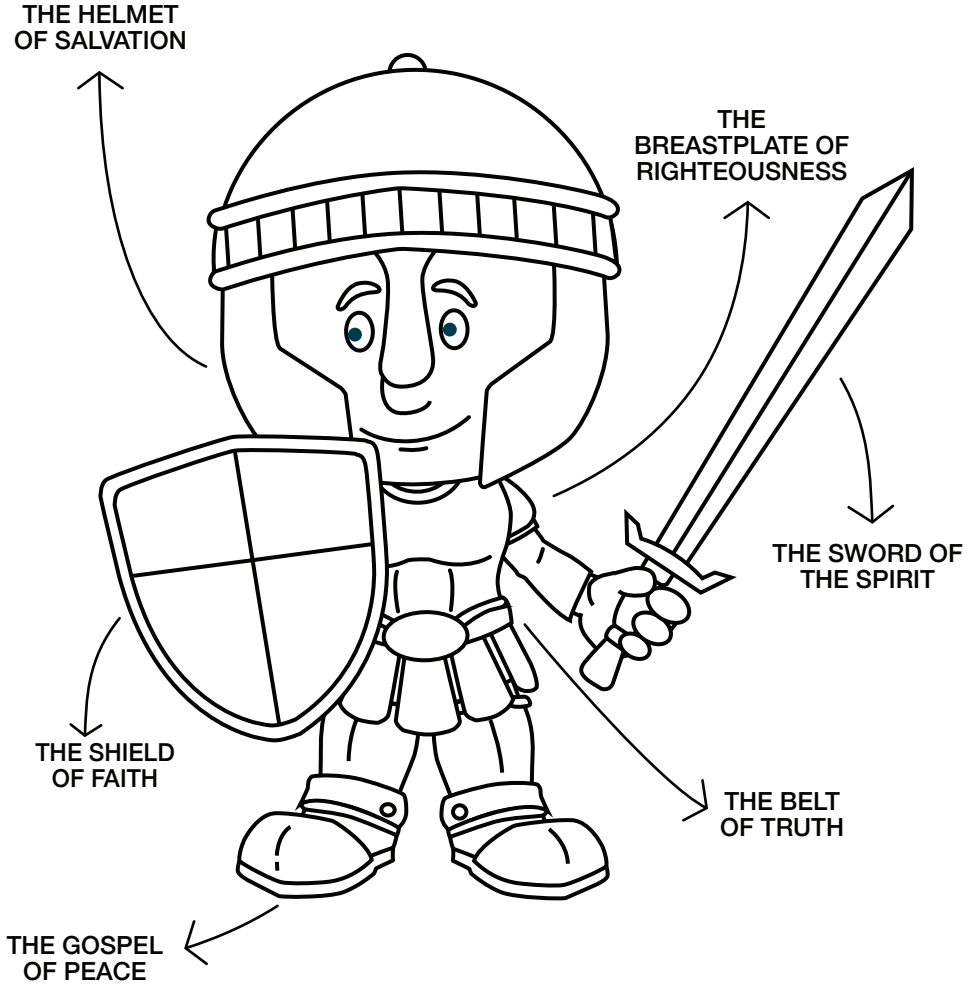

*Ephesians 6:11-18*

# PRAYERS FOR MY FAMILY

*Honor your father and your mother, so that you may live long in the land the LORD your God is giving you.  
(Exodus 20:12)*

---

**Jesus,**

Today, I thank You for my family.

I thank You that You love us and want the best for us.

I pray You would give (say their names) and me wisdom today to make good choices and do the things You would want us to do.

I pray that You will bless us so that we can be a blessing to others.

I pray You will give us favor and influence.

I pray You would lead us and guide us through the whole day and I pray that You will watch over everything we do.

I pray that You would cover us, protect us, and keep us far from any harm so that we can do good things for You.

In Jesus' name, amen.

---

---

---

# PRAYERS FOR WHEN I FEEL ALONE

*I will never leave you or let you be alone.  
(Hebrews 13:5 NLV)*

*I am with you always.  
(Matthew 28:20)*

---

**Jesus,**

Thank You that You are my best friend.

Thank You that You never leave me, and that I never have to feel alone.

As You are with me today, help me follow You and make good choices.

Help me forgive anyone who has hurt me.

Thank You for the comfort that Your Spirit brings me.

Help me be like You and choose to love people the way You love people.

In Jesus' name, amen.

# PRAYERS FOR WHEN I FEEL AFRAID

*For God has not given us a spirit of fear, but of power and of love and of a sound mind. (2 Timothy 1:7 NKJV)*

---

**Jesus,**

Today I pray against the spirit of fear.

I command it to go by the authority that You have given me by Your name.

I ask that you would give me peace, perfect love that casts out fear, and complete confidence in You.

Thank You that I don't have to be afraid.

Thank You that You are in control.

Thank You that You love me.

In Jesus' name, amen.

LIST BELOW WHAT YOU  
DON'T NEED TO BE AFRAID  
OF AND THE THINGS YOU  
CAN HAVE PEACE ABOUT!



# PRAYERS FOR PROTECTION

---

Jesus always wants to keep us safe because He loves us. There are three great things we can use to protect ourselves.

## **1. THE NAME OF JESUS**

Jesus tells us that He will protect us and keep us. He will cover us with His wings. The Bible says that the name of the Lord is a strong tower that we can run to so we can be kept safe.

## **2. THE COVERING OF THE BLOOD OF JESUS**

When Jesus died on the cross for us, His precious blood was shed. And that blood saved us, washes our sin away, and protects us.

## **3. THE WORD OF GOD (THE BIBLE)**

The Bible is full of prayers of protection. It is such a powerful weapon against the enemy. We can pray God's Word over us and our family. Psalm 91 is one of those great prayers of protection.



**Jesus,**

Thank You that I am important to You.

Thank You that You are always watching over me and protecting me.

I pray that You will cover me with the protection of Your blood and surround me with Your angels.

I run to the name of Jesus, my strong tower.

Thank You for being my rock and strong defender.

Please protect my family and me from every evil attack.

In Jesus' name, amen.

Read out loud Psalm 91 when you are finished praying.

---



# THE PRAYER OF JABEZ

---

*Jabez cried out to the God of Israel, "Oh, that You would bless me and enlarge my territory! Let Your hand be with me, and keep me from harm so that I will be free from pain." And God granted his request.  
(1 Chronicles 4:10)*

BLESSING

INFLUENCE

PRESENCE

PROTECTION

# 1 BLESSING

---

*"Oh, that You would bless me..." (1 Chronicles 4:10)*

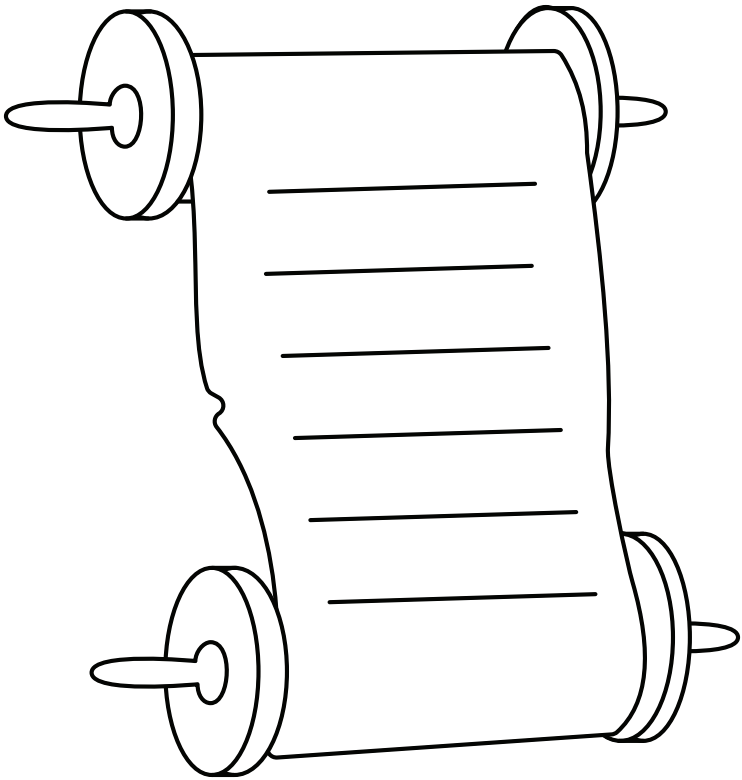

Jabez begins his prayer by asking God for His blessing. A blessing is like a good gift that is meant to help or encourage us. We need more of God's blessing so we can make a difference by helping others and showing them the love of Jesus. James 4:2-3 tells us, "You do not have because you do not ask God. When you ask, you do not receive, because you ask with wrong motives, that you may spend what you get on your pleasures." How cool is that? God wants to bless us, but He is often waiting for us to ask with the right heart and attitude. He wants to see that we don't just keep His blessings to ourselves but use them to bless others. We have a really big God, and we can be bold and hopeful in asking for His gifts and blessings. In the Bible, James says that God sees our heart and knows exactly what we need, but He wants to hear it from us. We get God's attention when we ask Him for blessings to help others.

Ask God for His blessing. Recognize that you need Him to give you more than you need so that you can be a blessing to others and show them the great love of Jesus.

**Prayer:**

"Father God, I know You care for me and You give me what I need. I don't want to be selfish in asking for things—give me more so that I can be generous and share Your blessings with others. Jesus, I want to be a blessing so that I can help lead others to You."

## 2 INFLUENCE

---

*"Enlarge my territory..." (1 Chronicles 4:10)*

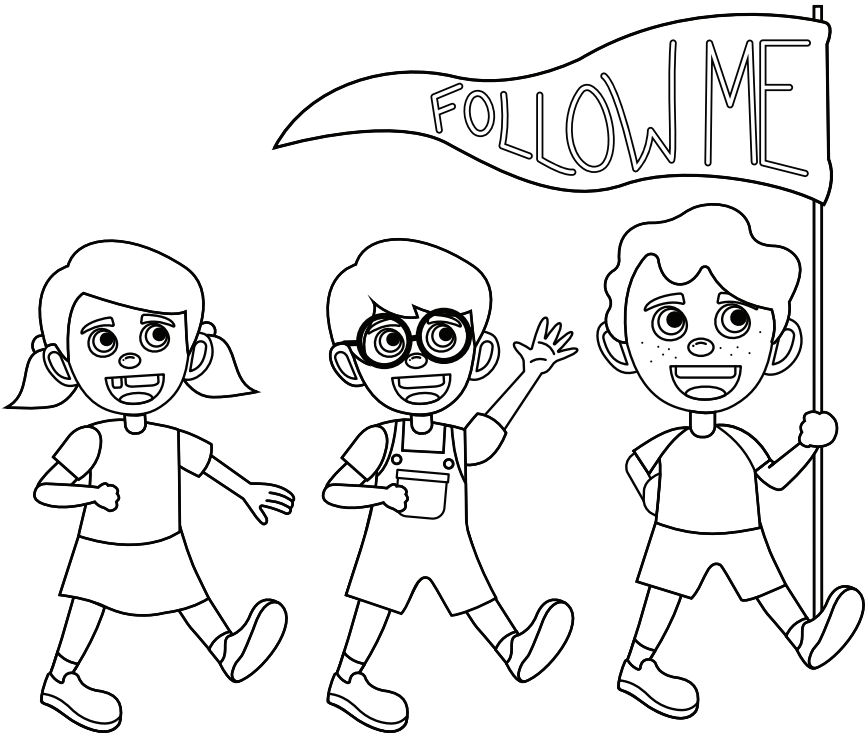

Next, Jabez asks for more influence. Jabez prayed that God would help make his territory bigger so that he could share God's blessings with more people. He wanted to be more successful in life so that he would have more opportunities to tell others about God and bring glory to Him. When God blesses us and gives us more, we also ask for more opportunity to influence the world around us for Jesus. God has the power to bless us greatly, and He also has the power to give us more ways to make a difference.

Pray for more influence. Pray that you will get to know more people that you can share God's love and blessings with.

**Prayer:**

“God, make me a better friend, a better classmate, and a better leader. Show me more ways that I can reach more people and show them who You are and how much You love them. Help me to take good care of the things You have given me, and help me make a difference in the lives of more people.”

### 3 PRESENCE

---

*"Let Your hand be with me..." (1 Chronicles 4:10)*

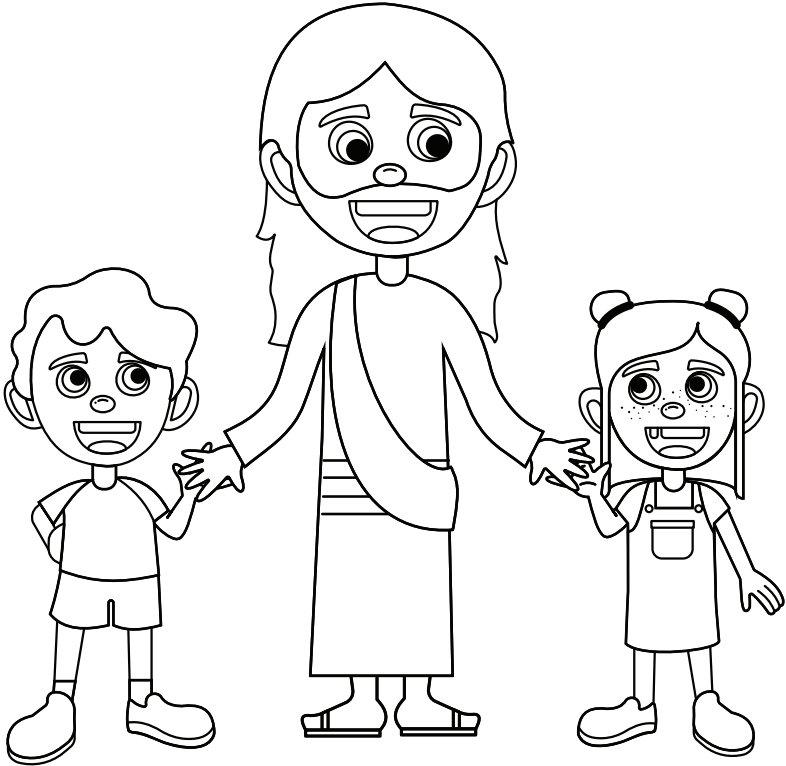

In order to reach more people, we need God's presence. God gives us power through the Holy Spirit to help us do more than we could ever ask or imagine (Ephesians 3:20). When we ask for blessing and influence, we also need to ask for God's presence to help us, so that we will not try to only do things in our strength. Jabez knew that he could not be successful by himself. He wanted God to put His hand on him to help him make good decisions.

Trust and depend on God—ask for more of Him in your life today. Be humble and admit that you can't do things alone, that you need God to be with you and to help you.

**Prayer:**

“Lord, I know that without You, I am nothing. I can't do what You've called me to do on my own. I need Your hand and I need You to be with me. I trust and depend on You completely. Help me, Lord. Thank You for giving me the power of Your Holy Spirit. The same power that raised Jesus from the dead now lives in me. Through the power of Your Spirit, I pray that You will help me succeed and do better in the things You have given me. Thank You for always being with me and keeping me safe.”

# 4 PROTECTION

---

*"Keep me from harm..." (1 Chronicles 4:10)*

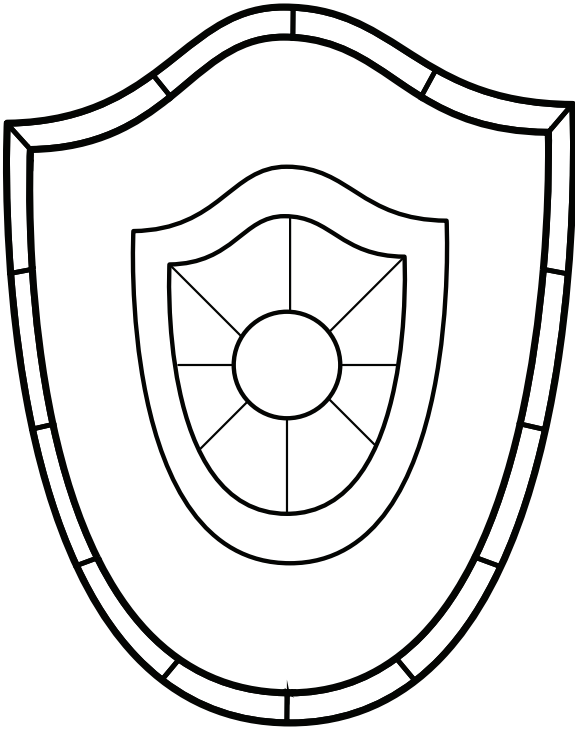



Finally, Jabez asks the Lord to protect him. He asks God to keep him safe so that he would be free from pain. If we are making a difference in the lives of others, we must understand that the devil will try to stop us. We can ask God to protect us, even before the enemy attacks. We do not need to be afraid—Jesus has already won the victory by what He did for us on the cross! We have nothing to fear because God promises to be with us and to protect us.

Trust God to protect you. Place your hopes in Him. Tell Him specific areas where you need His protection. Maybe it's at school, at home, or somewhere else. Ask Him to keep you from any harm in the future that you can't see yet.

**Prayer:**

“God, as I do the things you want me to do, I pray that You will stop every attack against me. Please keep me safe and protect my body, my mind, and my emotions. I pray that You will keep me from any hurt, harm, or danger. I also pray that You will protect my family and my friends. Jesus, I know that You love me and are watching over me. I know that I have nothing to fear because You already won the victory! Thank you for protecting me. I love You, and I trust You.”

# PRAYERS FOR OTHERS

*I urge, then, first of all, that petitions, prayers, intercession and thanksgiving be made for all people—for kings and all those in authority, that we may live peaceful and quiet lives in all godliness and holiness. This is good, and pleases God our Savior, who wants all people to be saved and to come to a knowledge of the truth.  
(1 Timothy 2:1-4)*

---

**Fill in the lists below with names of those in each category that you can be praying for.**

MY GOVERNMENT \_\_\_\_\_

MY CHURCH \_\_\_\_\_

MY SCHOOL \_\_\_\_\_

MY FAMILY \_\_\_\_\_

\_\_\_\_\_

\_\_\_\_\_

MY FRIENDS \_\_\_\_\_

\_\_\_\_\_

\_\_\_\_\_

PEOPLE WHO DON'T KNOW JESUS \_\_\_\_\_

\_\_\_\_\_





**COLOR A PICTURE OF  
SOMETHING YOU ARE  
BELIEVING GOD FOR.**

**COLOR A PICTURE OF AN  
ANSWERED PRAYER.**

# AWCIPA PRAYER MODEL

## A - ACKNOWLEDGE AND ADORE GOD

### SCRIPTURE:

*I will exalt you, my God the King; I will praise Your name forever and ever. (Psalm 145:1)*

ADMIRE - Tell God why He's awesome, fabulous, super-duper, etc. You can even go through the alphabet and say one word that describes God for each letter! For example: A - God, You're AWE-SOME! B - Jesus, You're my BEST FRIEND. C - Holy Spirit, You COMFORT me. Need some help? Ask a grown-up who loves God to show you what the Bible says about Him, and thank Him for being those things. The Bible is FULL of words that describe God.

### PRAYER:

*"God, thank You for my mom because she takes such good care of me. Thank you for my teacher because he is so patient. Thanks for my friends because we have so much fun together! God, thank You for my house because it's where I feel safe. Thanks so much for my school because the people there work so hard to help my friends and me. Thank You for the fun times I have with my family and for bringing us to a great church. "*

## W - WAIT QUIETLY BEFORE GOD

### SCRIPTURE:

*I wait for the Lord, my whole being waits, and in His word I put my hope. (Psalm 130:5)*

WAIT - Sit quietly and listen because God is talking to you about Himself, you, and others. He'll always tell you things that help you love better. What did you hear Him say? Write down what He tells you.

## C - CONFESS YOUR SIN AND IDENTITY

### SCRIPTURE:

*If we say that we have no sin, we deceive ourselves, and the truth is not in us. If we confess our sins, He is faithful and just to forgive us our sins and to cleanse us from all unrighteousness. (1 John 1:9)*

**CONFESS** - To “confess” means to speak the truth. Ask God to help you see things the way He sees them, and agree with Him. For example: Sin separates us from God, but He wants to be close with us; so ask Him to help you see your sin, and then ask for His forgiveness. He’ll do it because God forgives! Another example: God says only true things about Himself, you, and others. Read what the Bible says, or ask Him for a truth, and say it out loud. For added fun and volume, shout them out or cup your hands around your mouth, like a megaphone!

### PRAYER:

*Thank You, God, that You forgive us. I don't want to hide from you. I agree that I sinned and need your help to do the right thing. God, sorry for not doing things I know that I should have done. Sometimes I'm in a hurry or lazy or just don't want to do what's right. Help me choose to serve and obey out of love. Please forgive me for using unkind words and when I use an ugly tone or voice. Help my words to encourage others and not tear them down.*

Once you have confessed your sins, confess (speak the truth about) your identity in Him.

### PRAYER:

*I am awesome, I am smart, I am kind, I am important, I obey. What other kind words do you hear God telling you about yourself? Write them down and say them out loud every day!*



# I - INTERCEDE FOR OTHERS

## SCRIPTURE:

*Praying always with all prayer and supplication in the Spirit, being watchful to this end with all perseverance and supplication for all the saints. (Ephesians 6:18)*

INTERCEDE - Ask God to help others. Maybe it's a particular person, your enemies, friends, etc. Who needs help in your family, in your neighborhood, in your school, or in the world?

Example: Pray for leaders both locally and nationally. Ask God to bless those in power and guide them as they make important decisions. Praying for peace and unity in our world.

## PRAYER:

*God, please heal my mom from sickness. Help her to feel better. Help the kids who are not nice at school to have a happy heart and use kindness instead of words or actions that hurt others. I pray that people who don't know You will come to know you and love You.*

*God, give our leaders the wisdom to lead our country. Bring other men and women who love God around them. I pray for protection for our local officials, police, and firefighters. I pray they would all make God important in their lives. Bring peace, protection, and justice all over the world.*

*"Father God, the Bible says Your will is that everyone would repent (turn back toward you) and receive salvation (2 Peter 3:9). Therefore, I come to You in the name of Jesus, on behalf of (state the name of the person you are interceding for), asking that (he/she) would be born again. I align my will with Yours. And I acknowledge what Your word says: "Rescue those being led away to death; hold back those staggering toward slaughter" (Proverbs 24:11). Therefore, I ask You to use me in this process as an instrument of Your love so (he/she) would come to know You as Lord and Savior.*

## P - PETITION FOR YOURSELF

### SCRIPTURE:

*“Now this is the confidence that we have in Him, that if we ask anything according to His will, He hears us. (1 John 5:14)*

PETITION - Ask God to help you. What do you need help with?

Example: Try praying an adverb: Please help me to willingly and slowly do my school work and chores with a joyful heart.

Jesus taught His disciples to pray for God’s kingdom to come and His will to be done on earth as it is in heaven. Since the will of God is shown through His word, start by praying and confessing the Scriptures over your life and situation.

### PRAYER:

*Father, You know what I need before I open my mouth (Matthew 6:8). Your will for me is to prioritize seeking Your kingdom, and Your righteousness. Which means to put You first and do the things You want me to do. And if I do so, all of my needs will be met (Matthew 6:33). Therefore, I pray that I will always come to You first and try my best to obey. Please teach me how to honor and obey You, my parents, and leaders. I want to do the right thing. Help me to have joy, peace, and love for myself and others.*

## A - ACKNOWLEDGE AND ADORE GOD

### SCRIPTURE:

*I will praise You, O Lord my God, with all my heart, And I will glorify Your name forevermore. (Psalm 86:12)*

### PRAYER:

*“My Lord, my God, and my King, I love You with all my heart! I worship You for who You are (tell God who/what He is to you: your Father, Redeemer, holy, faithful, trustworthy, etc.). I praise You for all You’ve done, for what You are doing, and for what You are going to do! I will give you praise forever. In Jesus’ name, amen!”*



**ROCK CHURCH**

[SDROCK.COM](http://SDROCK.COM)